



Optimal productivity

- Up to 4 simultaneous, proportional movements
- 1.5m wide platform

Excellent manoeuvrability in the tightest spaces

- Narrow turning radius
- Zero tailswing

Outstanding rough terrain driving features

- 4 wheel drive
- Differential wheel lock
- 26 cm ground clearance





HA120 PX

ROUGH TERRAIN ARTICULATING BOOMS

TECHNICAL DATA

HA120 PX

Working height	12.4 m
Platform height	10.4 m
Horizontal outreach	6.6 m
Up and over clearance	5.7 m
Lift capacity	230 kg
Platform size	1.5 x 0.8 m
A Length	5.5 m
B Width	1.9 m
C Height - stowed	2.2 m
Vertical jib rotation	140° (+70/-70)
Platform rotation	180° (+90/-90)
Turntable rotation	350 °
Tailswing	0 m
D Wheelbase	1.92 m
E Ground clearance	26 cm
Tilt	5 °
Drive speed	0.7 - 5 km/h
Gradeability	45 %
Turning radius - outside	3.85 m
Tires - foam-filled	10.5/80-18
Power source	21 kW - 28.5 hp
Weight	5620 kg

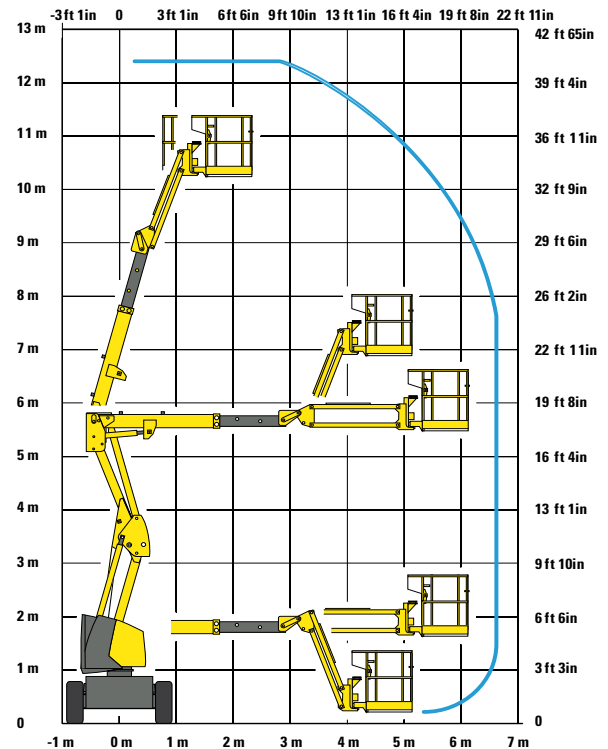

STANDARD EQUIPMENT

- Simultaneous and proportional movements for optimal productivity
- 4 wheel drive
- Ergonomic control panel
- Safe to use in winds up to 45km/h / 28mph
- Tilt controller
- Load Management System in the platform
- Automatic platform levelling
- 12V - 95A starting battery
- Towing hooks and lifting eyes
- Free wheeling device
- Mechanical turret slewing hook
- Emergency hand pump
- Horn
- Hourmeter

OPTIONS AND ACCESSORIES

- Rotating beacon
- Travel alarm
- Working light
- Power to platform
- Circuit-breaker
- Biodegradable hydraulic oil
- Auxiliary power in the platform for emergency descent
- Platform of 1,2 x 0,8 m

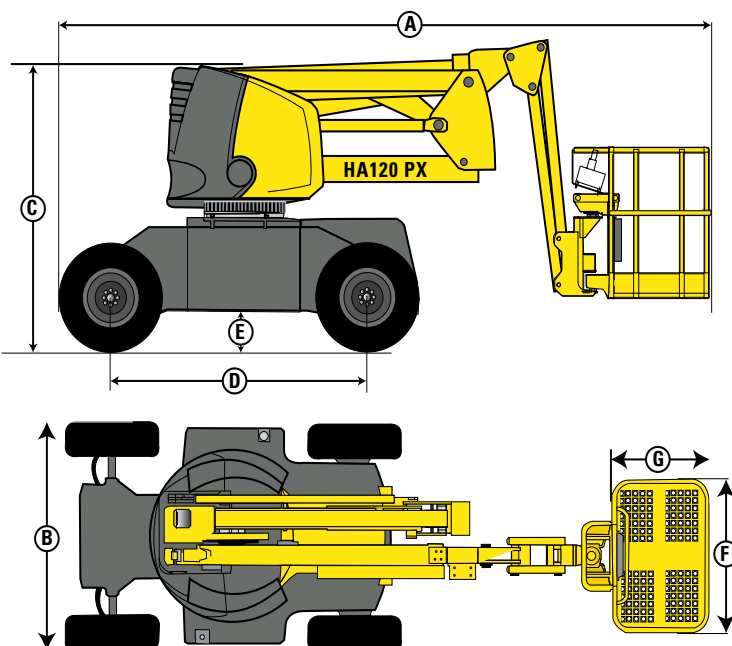

2420340030 - We reserve the right to modify the technical characteristics of this document without notice - 03/2012